

14" Metal/Wood Cutting Band Saw

INSTRUCTION MANUAL

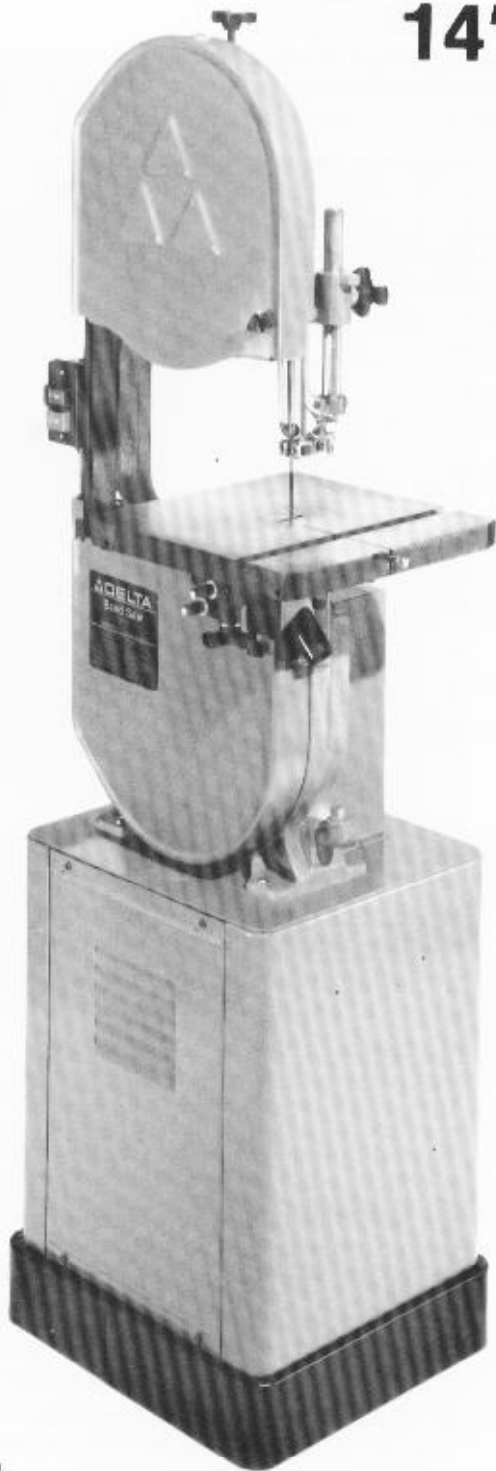

DATED 10-10-94

PART NO. 426-03-651-0010
© Delta International Machinery Corp. 1994

 **DELTA**

SAFETY RULES

Woodworking can be dangerous if safe and proper operating procedures are not followed. As with all machinery, there are certain hazards involved with the operation of the product. Using the machine with respect and caution will considerably lessen the possibility of personal injury. However, if normal safety precautions are overlooked or ignored, personal injury to the operator may result. Safety equipment such as guards, push sticks, hold-downs, featherboards, goggles, dust masks and hearing protection can reduce your potential for injury. But even the best guard won't make up for poor judgment, carelessness or inattention. Always use common sense and exercise caution in the workshop. If a procedure feels dangerous, don't try it. Figure out an alternative procedure that feels safer. REMEMBER: Your personal safety is your responsibility.

This machine was designed for certain applications only. Delta Machinery strongly recommends that this machine not be modified and/or used for any application other than that for which it was designed. If you have any questions relative to a particular application, DO NOT use the machine until you have first contacted Delta to determine if it can or should be performed on the product.

**DELTA INTERNATIONAL MACHINERY CORP.
MANAGER OF TECHNICAL SERVICES
246 ALPHA DRIVE
PITTSBURGH, PENNSYLVANIA 15238
(IN CANADA: 644 IMPERIAL ROAD, GUELPH, ONTARIO N1H 6M7)**

WARNING: FAILURE TO FOLLOW THESE RULES MAY RESULT IN SERIOUS PERSONAL INJURY

- 1. FOR YOUR OWN SAFETY, READ INSTRUCTION MANUAL BEFORE OPERATING THE TOOL.** Learn the tool's application and limitations as well as the specific hazards peculiar to it.
- 2. KEEP GUARDS IN PLACE** and in working order.
- 3. ALWAYS WEAR EYE PROTECTION.**
- 4. GROUND ALL TOOLS.** If tool is equipped with three-prong plug, it should be plugged into a three-hole electrical receptacle. If an adapter is used to accommodate a two-prong receptacle, the adapter lug must be attached to a known ground. Never remove the third prong.
- 5. REMOVE ADJUSTING KEYS AND WRENCHES.** Form habit of checking to see that keys and adjusting wrenches are removed from tool before turning it "on."
- 6. KEEP WORK AREA CLEAN.** Cluttered areas and benches invite accidents.
- 7. DON'T USE IN DANGEROUS ENVIRONMENT.** Don't use power tools in damp or wet locations, or expose them to rain. Keep work area well-lighted.
- 8. KEEP CHILDREN AND VISITORS AWAY.** All children and visitors should be kept a safe distance from work area.
- 9. MAKE WORKSHOP CHILDPROOF** - with padlocks, master switches, or by removing starter keys.
- 10. DON'T FORCE TOOL.** It will do the job better and be safer at the rate for which it was designed.
- 11. USE RIGHT TOOL.** Don't force tool or attachment to do a job for which it was not designed.
- 12. WEAR PROPER APPAREL.** No loose clothing, gloves, neckties, rings, bracelets, or other jewelry to get caught in moving parts. Non-slip footwear is recommended. Wear protective hair covering to contain long hair.
- 13. ALWAYS USE SAFETY GLASSES.** Wear safety glasses (must comply with ANSI Z87.1). Everyday eyeglasses only have impact resistant lenses; they are not safety glasses. Also use face or dust mask if cutting operation is dusty.
- 14. SECURE WORK.** Use clamps or a vise to hold work when practical. It's safer than using your hand and frees both hands to operate tool.
- 15. DON'T OVERREACH.** Keep proper footing and balance at all times.
- 16. MAINTAIN TOOLS IN TOP CONDITION.** Keep tools sharp and clean for best and safest performance. Follow instructions for lubricating and changing accessories.
- 17. DISCONNECT TOOLS** before servicing and when changing accessories such as blades, bits, cutters, etc.
- 18. USE RECOMMENDED ACCESSORIES.** The use of improper accessories may cause hazards or risk of injury to persons.
- 19. REDUCE THE RISK OF UNINTENTIONAL STARTING.** Make sure switch is in "OFF" position before plugging in power cord.
- 20. NEVER STAND ON TOOL.** Serious injury could occur if the tool is tipped or if the cutting tool is accidentally contacted.
- 21. CHECK DAMAGED PARTS.** Before further use of the tool, a guard or other part that is damaged should be carefully checked to ensure that it will operate properly and perform its intended function - check for alignment of moving parts, binding of moving parts, breakage of parts, mounting, and any other conditions that may affect its operation. A guard or other part that is damaged should be properly repaired or replaced.
- 22. DIRECTION OF FEED.** Feed work into a blade or cutter against the direction of rotation of the blade or cutter only.
- 23. NEVER LEAVE TOOL RUNNING UNATTENDED. TURN POWER OFF.** Don't leave tool until it comes to a complete stop.
- 24. DRUGS, ALCOHOL, MEDICATION.** Do not operate tool while under the influence of drugs, alcohol or any medication.
- 25. MAKE SURE TOOL IS DISCONNECTED FROM POWER SUPPLY** while motor is being mounted, connected or reconnected.
- 26. WARNING:** The dust generated by certain woods and wood products can be injurious to your health. Always operate machinery in well ventilated areas and provide for proper dust removal. Use wood dust collection systems whenever possible.

ADDITIONAL SAFETY RULES FOR BAND SAWS

- 1. ADJUST** the upper guide about 1/8" above the material being cut.
- 2. MAKE SURE** that blade tension and blade tracking are properly adjusted.
- 3. STOP** the machine before removing scrap pieces from the table.
- 4. ALWAYS** keep hands and fingers away from blade.
- 5. CHECK** for proper blade size and type.
- 6. DO NOT** attempt to saw stock that does not have a flat surface, unless a suitable support is used.
- 7. HOLD** material firmly and feed into blade at a moderate speed.
- 8. TURN OFF** machine if the material is to be backed out of an uncompleted cut.
- 9. MAKE** "release" cuts before cutting long curves.

UNPACKING AND CLEANING

Carefully unpack the band saw and all loose items from the shipping container. Remove the protective coating from the machined surfaces of the band saw. This coating may be removed with a soft cloth moistened with kerosene (do not use acetone, gasoline or lacquer thinner for this purpose). After cleaning, cover all unpainted surfaces with a good quality paste wax.

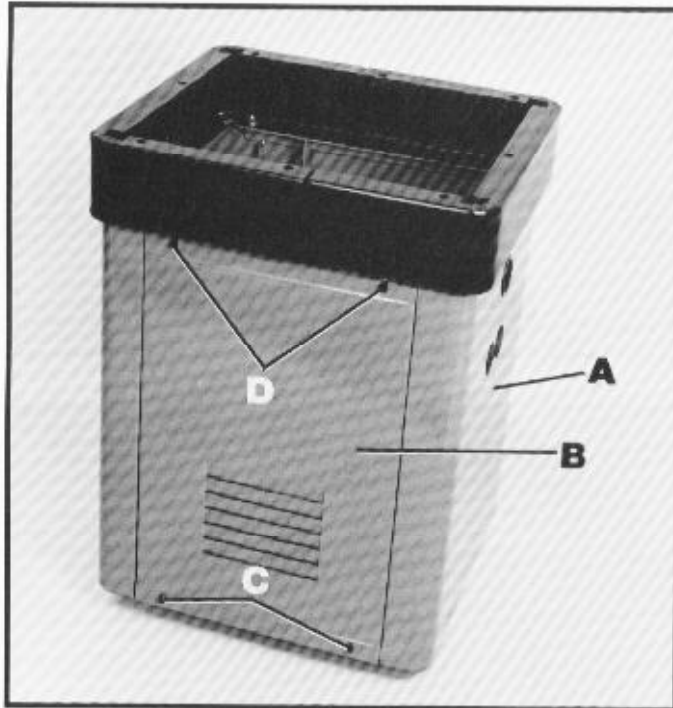

Fig. 1

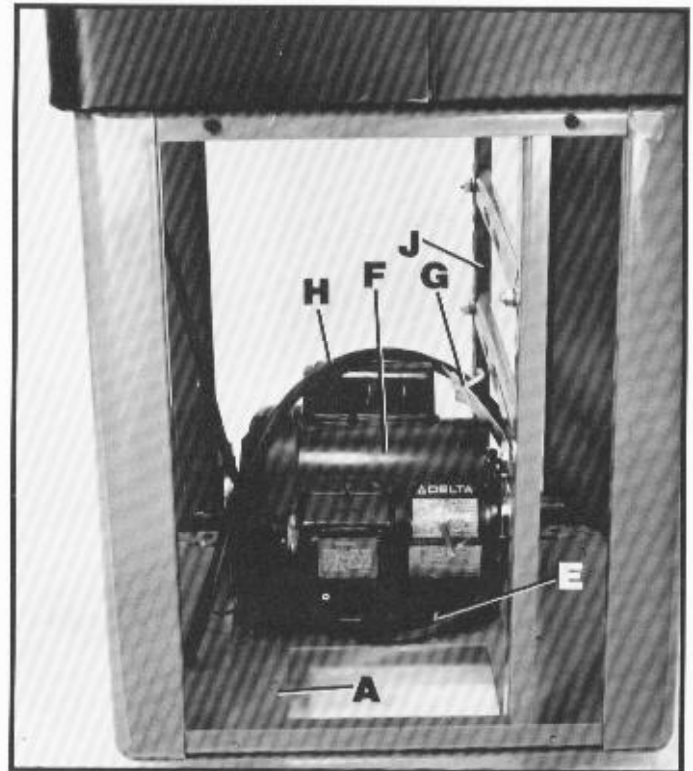

Fig. 2

ASSEMBLY STAND

If you purchased your band saw complete with stand and electricals, the stand is shipped top down inside the shipping container with the motor mounted to the inside top of the stand. The on/off switch is wired to the end of the power cord.

The motor must be removed from the inside top of the stand and reassembled to the horizontal mounting bars inside the stand as follows:

1. Remove the stand (A) Fig. 1, from the shipping container being careful not to crimp the switch cord which extends through the top of the stand. **NOTE:** Set the stand on several blocks of wood to raise the stand off the floor surface.
2. Remove panel (B) Fig. 1, from stand (A) by removing two screws (C) and loosening two screws (D). Remove panel on opposite side of stand in the same manner.
3. Remove two mounting screws, one of which is shown at (E) Fig. 2, that are holding motor (F) to the top of stand (A). **IMPORTANT: DO NOT REMOVE CABLE TIE (G) THAT IS HOLDING SWITCH CORD (H) TO VERTICAL MOUNTING BAR (J), UNLESS YOU ARE USING THE ACCESSORY 28-984 HEIGHT ATTACHMENT ON THE BAND SAW. THIS CABLE TIE (G), WILL KEEP THE SWITCH CORD (H) FROM CONTACTING THE MOTOR PULLEY OR BELT DURING OPERATION.**

ASSEMBLING MOTOR TO STAND

1. To make the motor assembly easier, turn stand (A) Fig. 2A, on its side with two horizontal bars (B) down as shown.
2. Position motor (C) Fig. 2A, on two horizontal support bars (B) as shown, and fasten with four 3/4" long carriage bolts, two of which are shown at (D), and four flanged nuts. **IMPORTANT:**

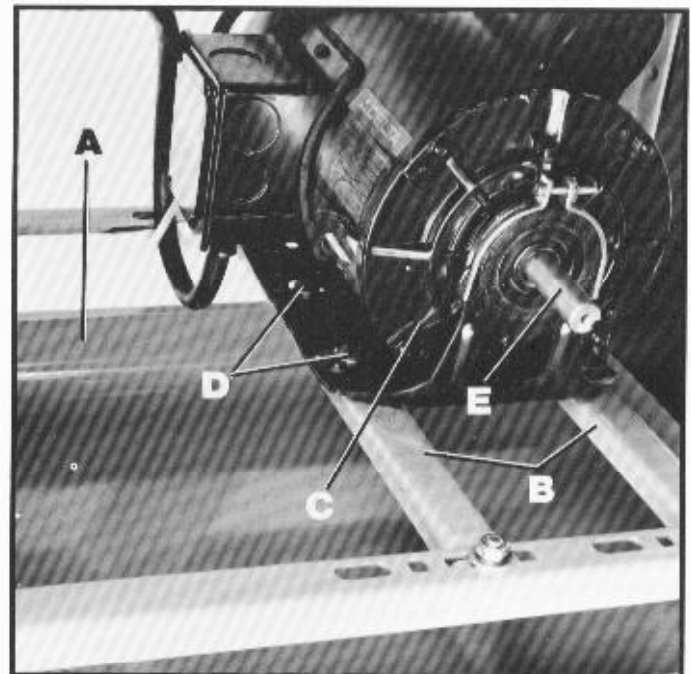

Fig. 2A

MAKE CERTAIN MOTOR SHAFT (E) IS ON THE SAME SIDE OF THE STAND AS THE LARGE OPENING IN THE TOP OF THE STAND BEFORE TIGHTENING CARRIAGE BOLTS (D). Further motor alignment will be necessary after band saw is fastened to stand.

3. Carefully turn the stand right side up.

ASSEMBLING BAND SAW TO STAND

Assemble the band saw to the stand, as shown in Fig. 3, using the four 5/16-18 x 1-3/4" round head slotted screws, 5/16" flat washers, 5/16" lockwashers and 5/16"-18 hex nuts.

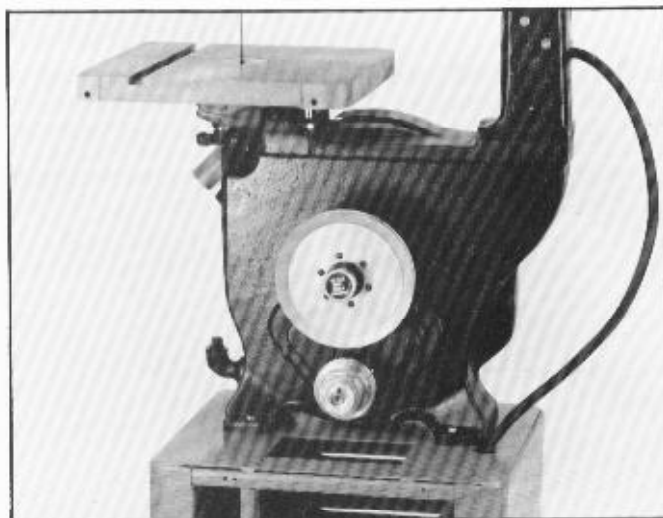

Fig. 3

ASSEMBLING MOTOR PULLEY

Both the motor pulley (A) Fig. 4, and the gear box pulley (B) are four step pulleys and should always be assembled opposite each other. Check to see if the gear box pulley (B) is assembled with the largest step of the pulley in the "in" or "out" position. In this case the largest step of the gear box pulley (B) is in the "in" position. Then assemble the motor pulley (A) to the motor shaft with the largest step of the motor pulley in the "out" position, as shown. **NOTE:** When assembling the motor pulley (A) to the motor shaft it is necessary to use the 3/4" to 5/8" reducing bushing on the motor shaft. Delta motors recommended for use with this band saw have 5/8" motor shafts. The motor pulley (A) is supplied with a 3/4" bore to enable it to be interchanged with the gear box pulley (B), as explained later in this manual.

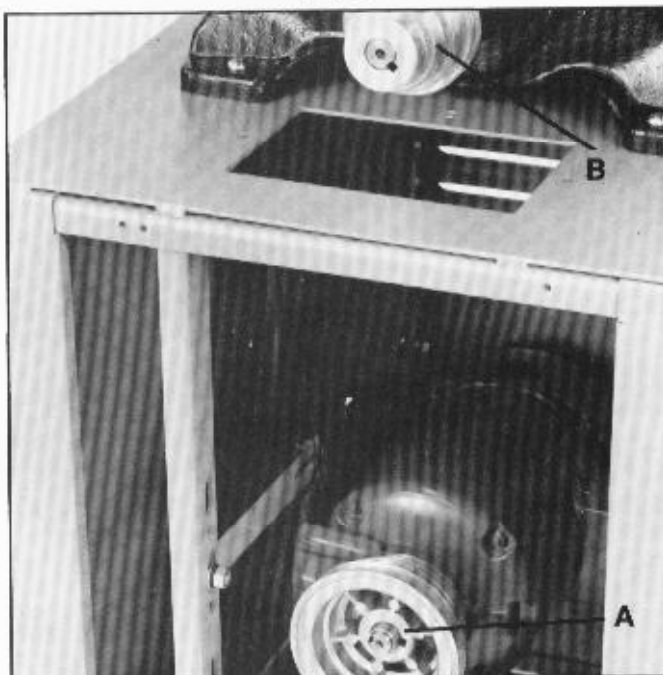

Fig. 4

ALIGNING PULLEYS, ASSEMBLING BELTS AND ADJUSTING BELT TENSION

1. Using a straight edge, align the inside grooves of the pulleys (A) and (B) to the inside edge of the driven pulley (C) Fig. 5. The pulleys can be moved in or out on the shafts and the motor can be moved lengthwise if necessary.
2. Assemble the largest V-Belt to the inside groove of the motor pulley (A) and to the driven pulley (C) Fig. 5. Assemble the smaller V-Belt to any one of the remaining three grooves of the motor pulley (A) and the corresponding groove of the gear box pulley (B).
3. Adjust for proper belt tension by raising or lowering the motor on the motor mounting bars. If necessary the motor mounting bars can be repositioned on the two posts (D) Fig. 5. Make certain pulleys are kept in alignment when doing this. Correct belt tension is obtained when there is approximately 1" deflection in the center span of the pulleys with light finger pressure.

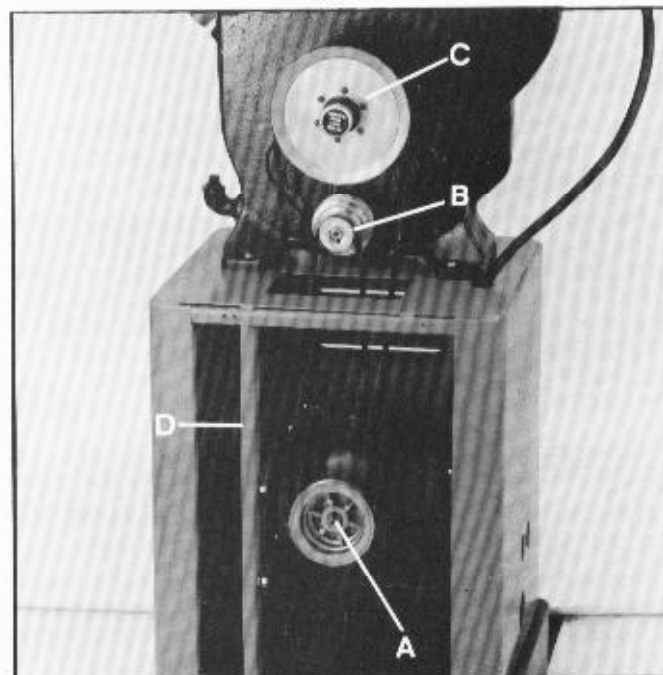

Fig. 5

ASSEMBLING BELT AND PULLEY GUARD

Place the belt and pulley guard (A) Fig. 6, on the top shelf over the belt opening and position the two clamps (B) over the guard flanges and under the top of the stand as shown. Use the four round head screws in holes in the bottom of the clamps to fasten in place. Place door (C) on hinges of the belt and pulley guard.

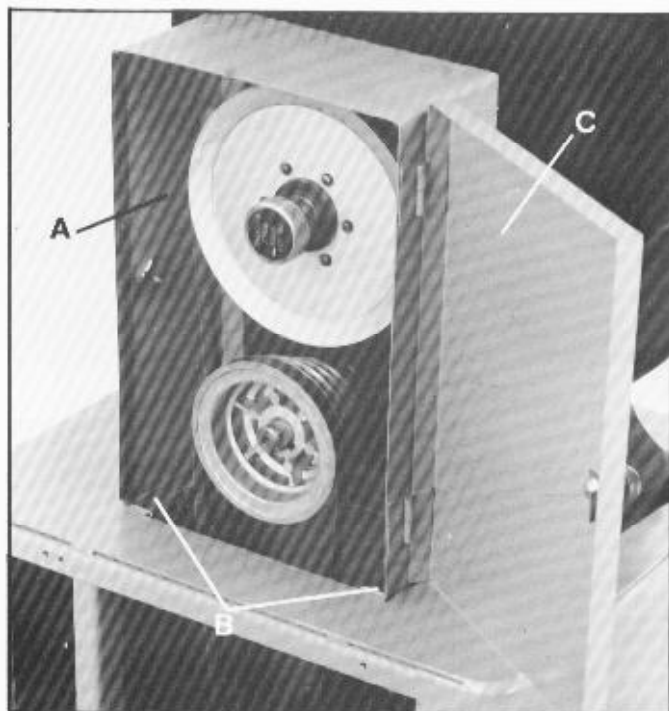

Fig. 6

ASSEMBLING SWITCH

If you purchased your band saw complete with stand and electricals, you received a switch mounted in a switch box and a cord set connected to the motor. Assemble the switch to the band saw arm as follows:

1. **MAKE CERTAIN THE BAND SAW IS DISCONNECTED FROM THE POWER SOURCE.**

2. **CAUTION: THE ON/OFF SWITCH-TO-MOTOR CORD (F) FIG. 7, IS TIED TO VERTICAL MOUNTING POST (G) OPPOSITE THE MOTOR PULLEY. THIS CABLE TIE (H) PREVENTS THE SWITCH-TO-MOTOR CORD (F), FROM CONTACTING THE BELT OR MOTOR PULLEY DURING OPERATION. DO NOT TIGHTEN CABLE TIE (H) AT THIS TIME. IMPORTANT: DO NOT REMOVE THIS CABLE TIE UNLESS YOU ARE USING THE ACCESSORY #28-984 HEIGHT ATTACHMENT WITH THE BAND SAW.**

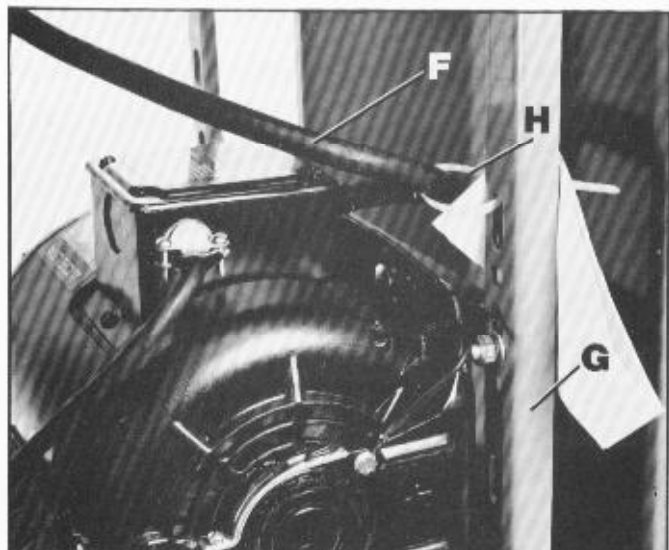

Fig. 7

3. Remove two outer hex nuts and lockwashers (A) Fig. 7A, from the two screws extending out from the back of the switch box (B).

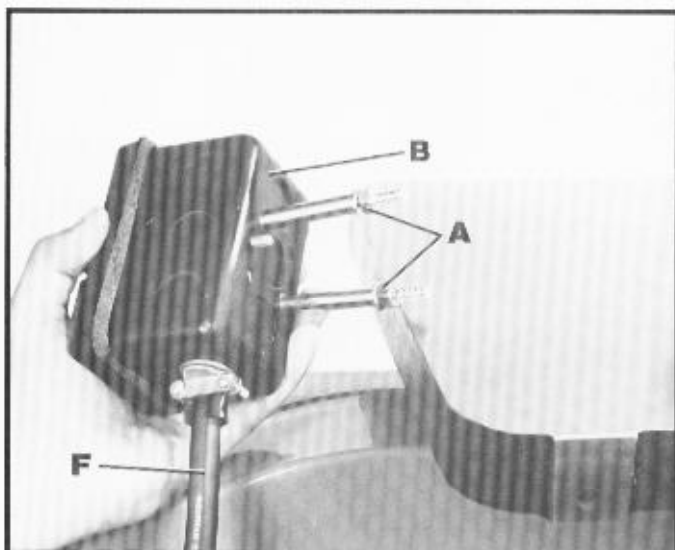

Fig. 7A

4. Insert two screws (C) Fig. 8, located on back of switch box, into two holes (D) located in the band saw arm.

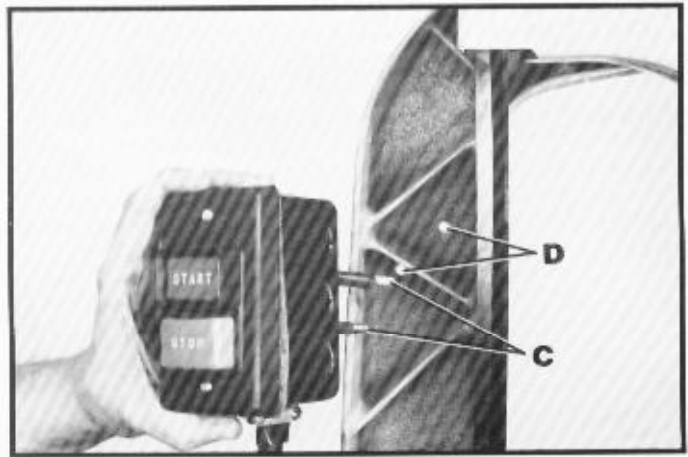

Fig. 8

5. Fasten the switch box to the band saw arm using two nuts and lockwashers (A) Fig. 9, which were removed in STEP 3.

6. Remove screw and cable clamp (E) Fig. 9A, from lower arm of band saw.

7. Insert switch cord (F) Fig. 10, into clamp (E) which was removed in STEP 6, and fasten switch cord (F) to band saw as shown. **IMPORTANT: CHECK AND MAKE CERTAIN THE ON/OFF SWITCH-TO-MOTOR CORD (F) FIG. 7, IS NOT CONTACTING MOTOR PULLEY OR BELT. ADJUST CORD (F) FIG. 7, IF NECESSARY, THEN TIGHTEN CABLE TIE (H).**

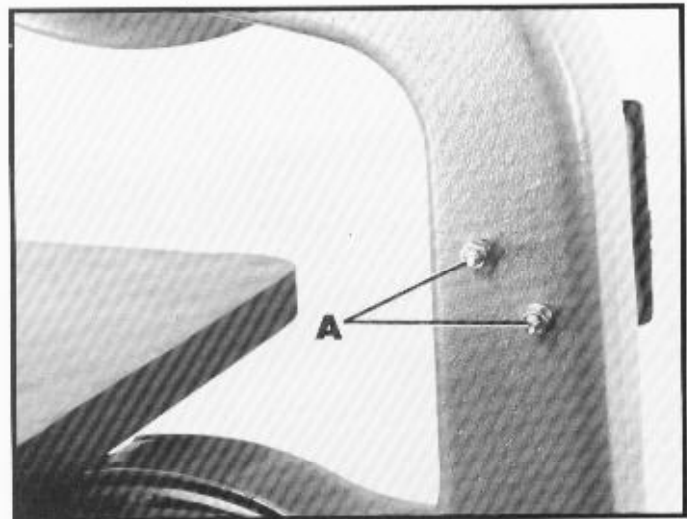

Fig. 9

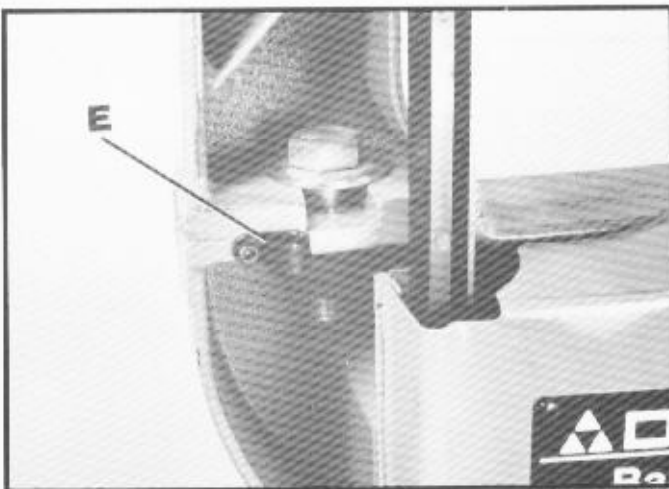

Fig. 9A

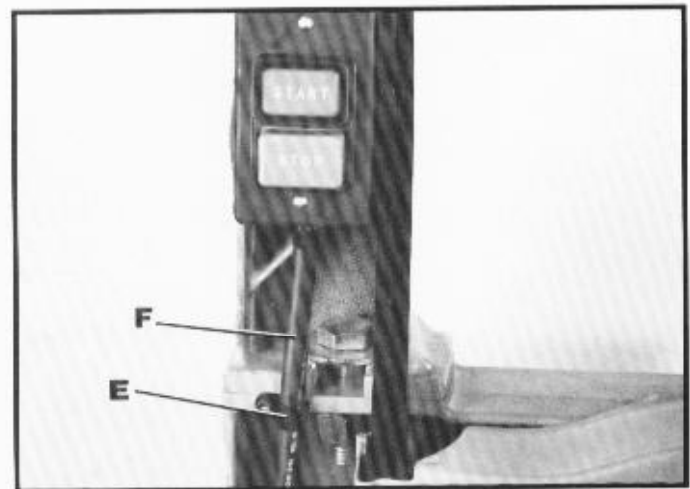

Fig. 10

TABLE INSERT

Place table insert (A) Fig. 11, in the hole provided in the table, making sure the pin (B) in the table engages one of the indents in the table insert.

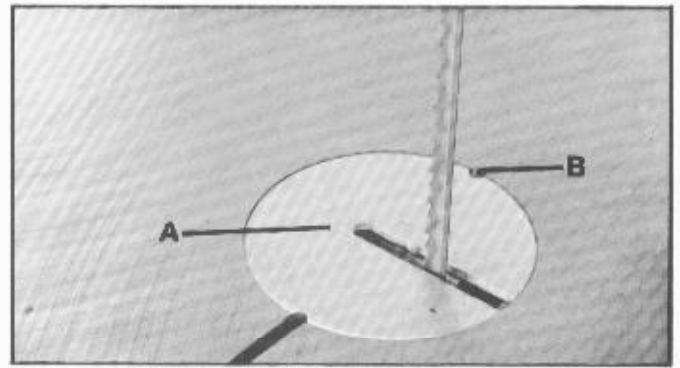

Fig. 11

TILTING THE TABLE

The table on your band saw can be tilted 45 degrees to the right and 10 degrees to the left. To tilt the table, loosen the two lock knobs (A) Fig. 12, tilt the table to the desired angle and tighten the two lock knobs (A).

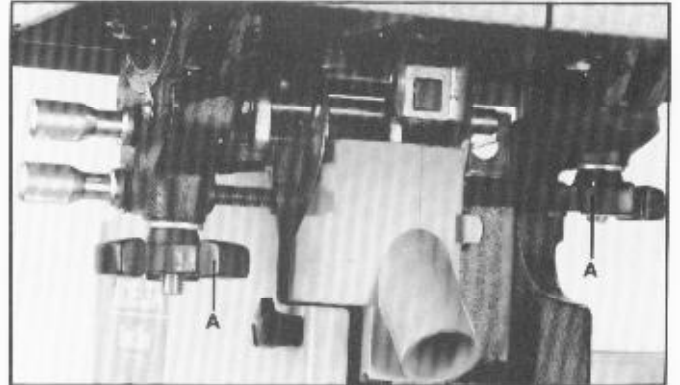

Fig. 12

ADJUSTING TABLE STOP

The band saw is equipped with an adjustable table stop (A) Fig. 13, that allows the table to be set perfectly at 90 degrees with the blade.

Tilt the table to the left until the table stop (A) Fig. 13, contacts the bottom of the table. Place a square on the table and against the blade as shown in Fig. 14, and check to see if the blade is 90 degrees to the table surface. If an adjustment is necessary, proceed as follows:

1. Tilt the table slightly to the right and tighten table lock knobs.
2. Turn adjustment nut (B) Fig. 13, right or left as necessary to raise or lower table stop (A). **IMPORTANT:** Certain models of band saws will have an additional locknut assembled to the end of the table stop (A) Fig. 13, directly under casting (C). Loosen locknut and turn adjustment nut (B) right or left as needed to raise or lower the table stop (A). Tighten locknut after adjustment is made.
3. Lower the table and make certain the table is 90 degrees to the blade as shown in Fig. 14.
4. It is necessary to remove the adjustable table stop (A) Fig. 13, when tilting the table to the left.

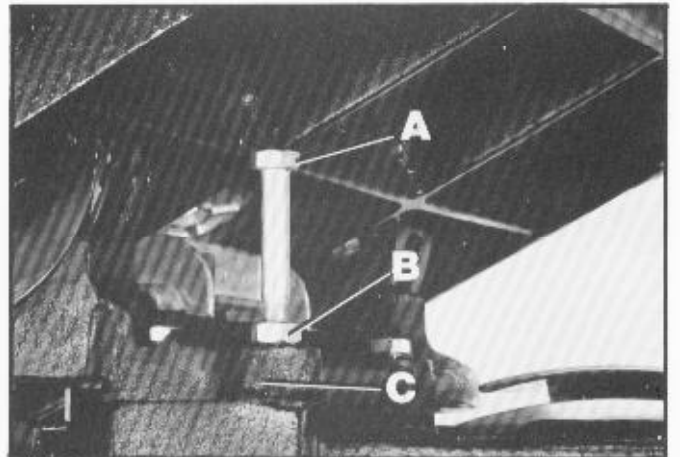

Fig. 13

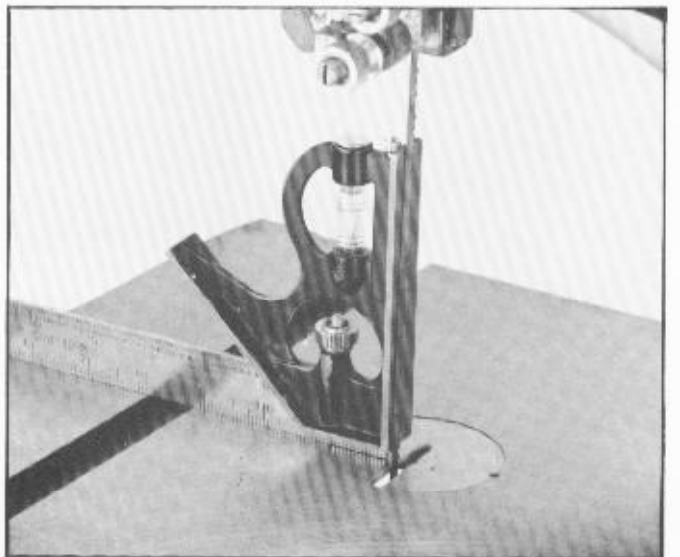

Fig. 14

ADJUSTING BLADE TENSION

On the back of the upper wheel slide bracket, there is a series of graduations. These indicate the proper tension for various widths of blades. With the blade on the wheels, turn the knob (A) Fig. 15, to raise or lower the wheel, until the red fiber washer (B) is in line with the proper graduation for the size of blade being used.

The graduations will be found correct for average work, and are not affected by rebrazing of the saw blade. We urge you to use these graduations until you have become familiar enough with the operation of the Band Saw to vary the tension for different kinds of blades or work. Over-straining is a common cause of blade breakage and other unsatisfactory blade performance. Release the tension when the machine is not in use.

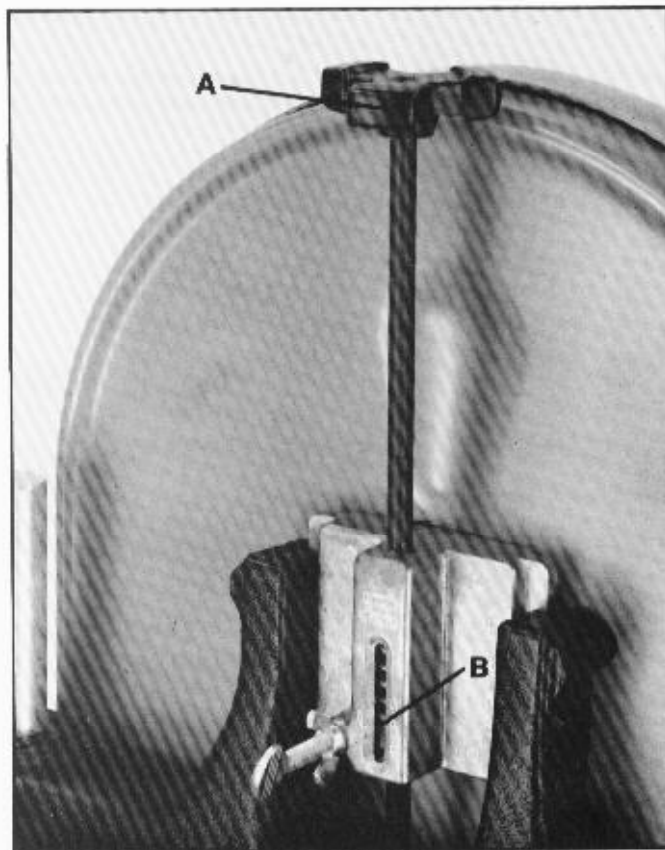

Fig. 15

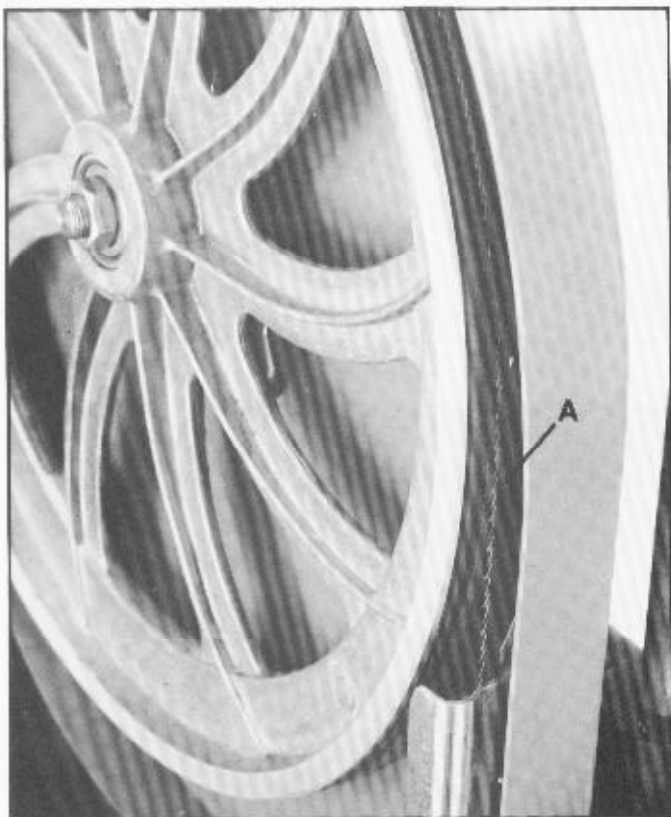

Fig. 16

TRACKING THE BLADE

IMPORTANT: Before tracking the blade, make sure the blade guides and blade support bearings are clear of the blade so as not to interfere with the tracking adjustment.

After tension has been applied to the blade, revolve the wheels slowly forward by hand and watch the blade (A) Fig. 16, to see that it travels in the center of the upper tire. If the blade begins to creep toward the front edge, loosen the wing nut (B) Fig. 17, and tighten the thumb screw (C). This will tilt the top of the wheel toward the back of the machine and will draw the blade toward the back edge, turn the thumb screw in the opposite direction. Adjust the thumb screw (C) Fig. 17, only a fraction of a turn at a time. **NEVER TRACK THE BLADE WHILE THE MACHINE IS RUNNING.** After the blade is tracking in the center of the tires, tighten the wing nut (B) Fig. 17.

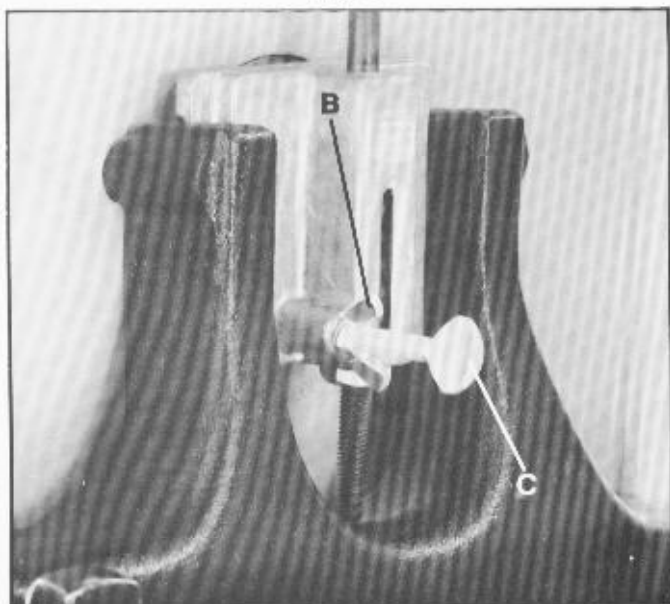

Fig. 17

ADJUSTING UPPER BLADE GUIDE ASSEMBLY

The upper blade guide assembly (A) Fig. 18, should always be set as close as possible to the top surface of the material being cut by loosening lock knob (B) and moving the guide assembly (A) to the desired position.

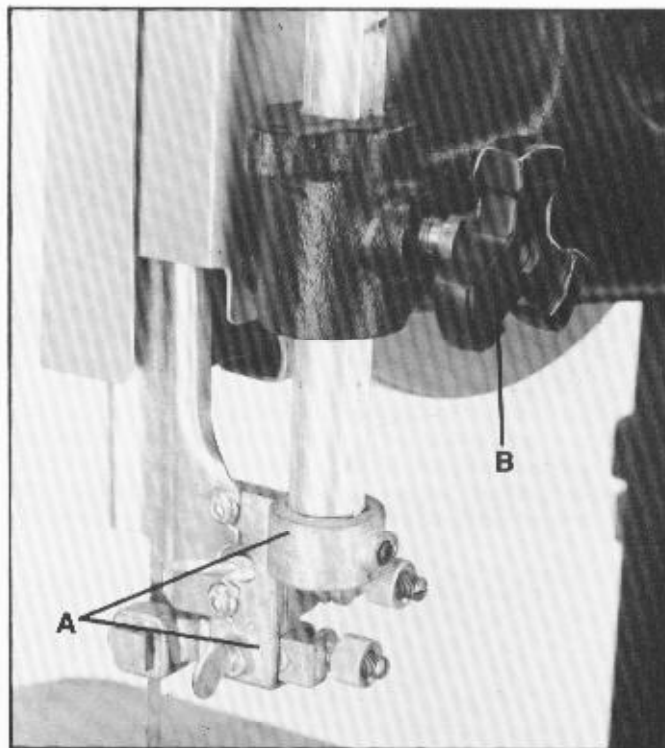

Fig. 18

The upper blade guide assembly should also be adjusted so that the blade guides (A) Fig. 19, are flat with the blade. If an adjustment is necessary, loosen screw (B) and rotate the complete guide assembly (C) until the blade guides are flat with the blade.

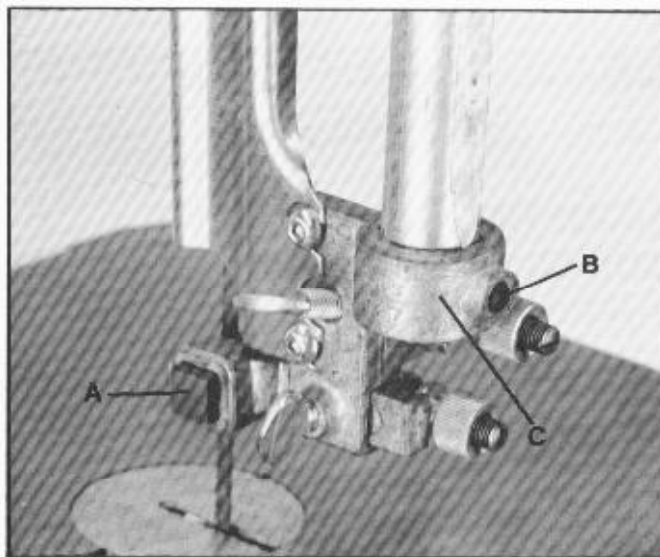

Fig. 19

ADJUSTING UPPER BLADE GUIDES AND BLADE SUPPORT BEARING

The upper blade guides and blade support bearings are adjusted only after the blade is tensioned and tracking properly. To adjust proceed as follows:

1. The upper blade guides (A) Fig. 20, are held in place by means of the set screws (B). Loosen the set screws (B) to move the guides (A) as close as possible to the side of the blade, being careful not to pinch the blade. Then tighten the screws (B).
2. The guides (A) Fig. 20, should then be adjusted so that the front edge of the guides are just behind the "gullets" of the saw teeth. The complete guide block bracket can be moved in or out by loosening thumb screw (C) and turning knurled knob (D) Fig. 20. When guides (A) are set properly, tighten thumb screw (C).
3. The upper blade support bearing (E) Fig. 20, prevents the blade from being pushed too far to the back which could damage the set in the saw teeth. The support bearing (E) should be set $1/64$ " behind the blade by loosening thumb screw (F) and turning knurled knob (G) to move the support bearing (E) in or out.
4. The blade support bearing (E) should also be adjusted so the back edge of the blade overlaps the outside diameter of the ball bearing by about $1/16$ ". The bearing (E) is set on an eccentric and to change position remove screw (H) and bearing (E) Fig. 20. Loosen thumb screw (F), back out screw (G) and reposition shaft that bearing (E) is attached to.

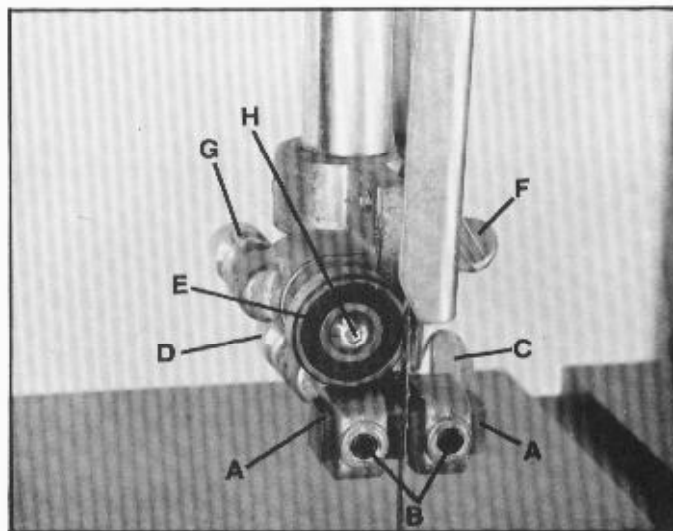

Fig. 20

ADJUSTING LOWER BLADE GUIDES AND BLADE SUPPORT BEARING

The lower blade guides and blade support bearing should be adjusted at the same time as the upper guides and bearing as follows:

1. Loosen the two screws (A) Fig. 21, and move the guides (B) as close as possible to the side of the blade, being careful not to pinch the blade. Then tighten screws (A).
2. The front edge of the guide blocks (B) should be adjusted so they are just behind the "gullets" of the saw teeth by turning the knurled knob (C) Fig. 21.
3. The lower blade support bearing (D) Fig. 21, should be adjusted so it is about $1/64$ " behind the back of the blade by turning the knurled knob (E).

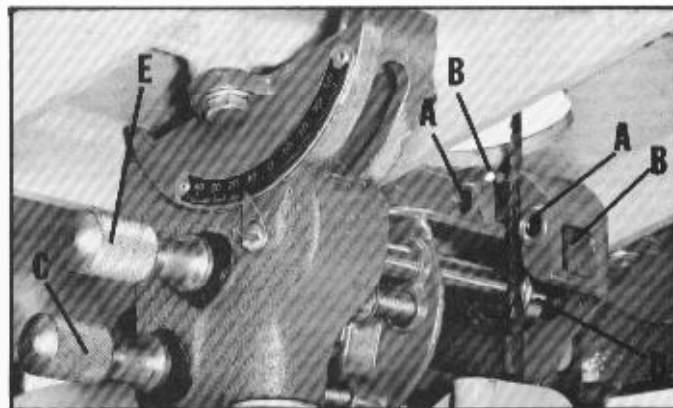

Fig. 21

CHANGING SPEEDS

One of the advantages of this saw lies in the fact that it can be changed over instantly from a slow-speed metal cutting band saw to a standard high-speed band saw for wood.

NEVER HAVE THE BAND SAW RUNNING WHEN CHANGING FROM METAL CUTTING TO WOOD CUTTING OR VICE-VERSA.

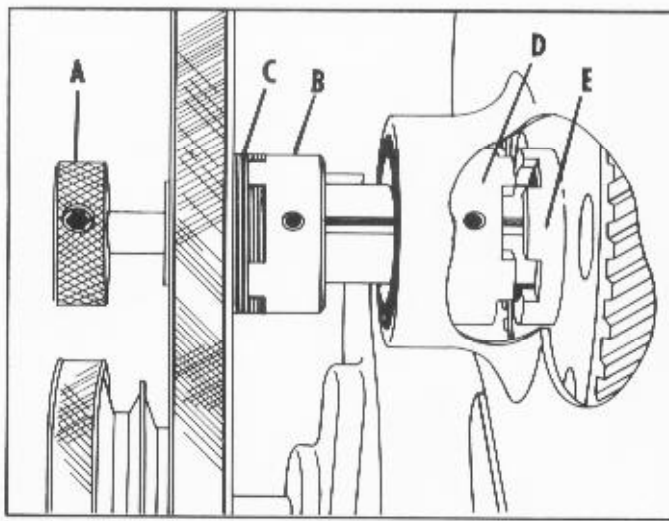

Fig. 22

When using your machine for wood cutting (3000 FPM), the shifter knob (A) Fig. 22 is always pulled out, all the way so that the lugs of the clutch (B) are engaged with the hub (C) of the driven pulley. This will disengage the clutch (D) from the hub (E) of the gear that transmits power through the gear box, as shown in Fig. 22. It may be necessary to rotate the pulley manually in order to line up the clutch lugs with the slots in the hub of the pulley. This provides a direct drive from the motor pulley to the driven pulley, by-passing the gear box.

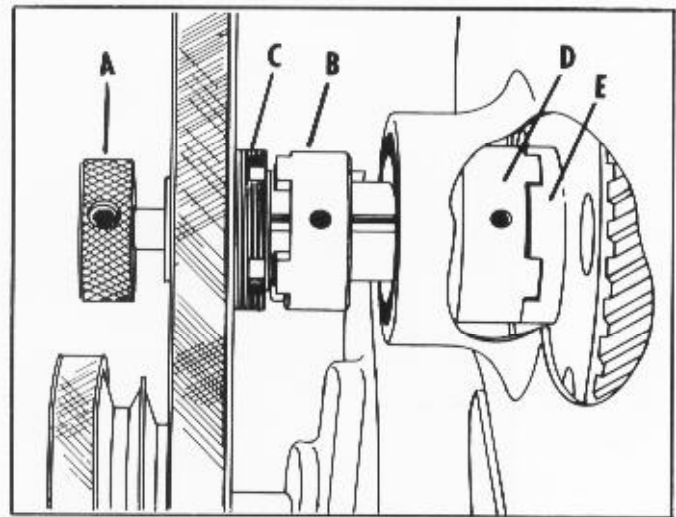

Fig. 23

When using your machine for metal cutting (40, 60, 85, 115, 160, 220 and 335 FPM), the shifter knob (A) Fig. 23 is always pushed in all the way, disengaging the clutch (B) from the hub (C) of the pulley. An additional clutch (D) is located inside the band saw and must be engaged with the hub (E) of the gear that transmits power through the gear box, as shown in Fig. 23. When pushing in on the shifter knob (A) Fig. 23 rotate the lower wheel of the band saw, and you will be able to feel when engagement occurs.

The following is an explanation for the belt and pulley arrangements to enable you to obtain all eight speeds available on your band saw:

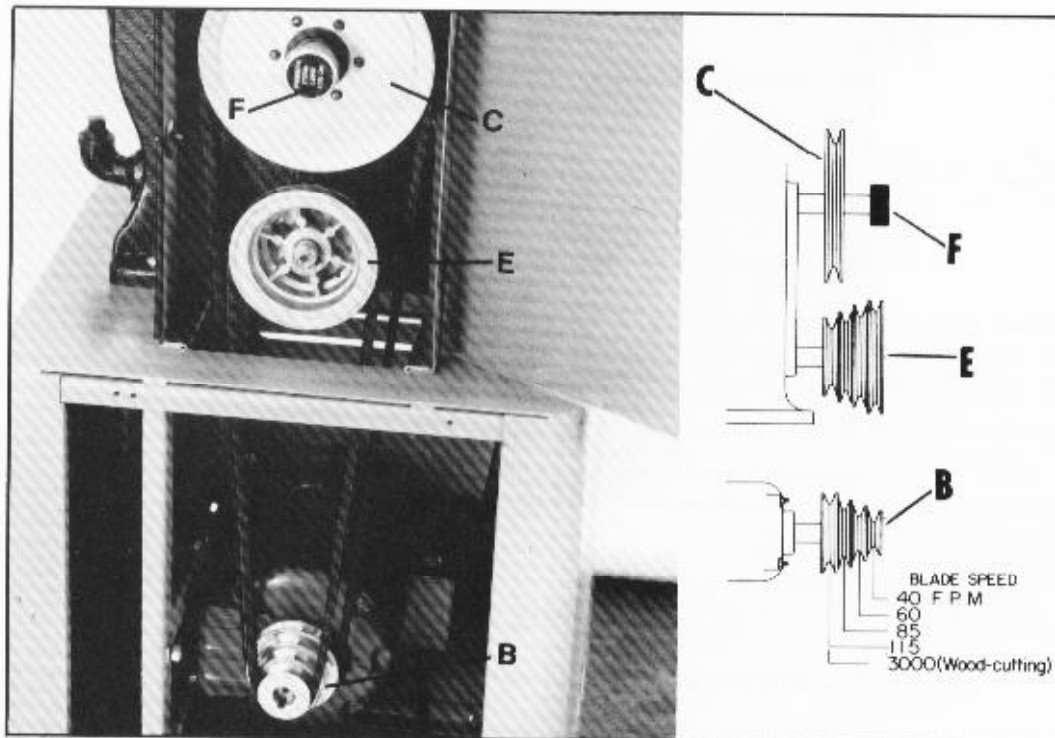

Fig. 24

With the longest belt on the inside groove of the motor pulley (B) and on the driven pulley (C), as shown in Fig. 24, and the small belt in one of the remaining three grooves of the motor pulley and the corresponding groove of the gear box pulley (E), speeds of 40, 60, 85, and 3000 FPM are readily available. To obtain speeds of 40, 60, and 85 FPM, the shifter knob (F) Fig. 24, must be pushed all the way in, as previously explained, and the small belt positioned on one of the three outside grooves of the motor pulley (B) and the gear box pulley (E).

To obtain a blade speed of 3000 FPM, simply pull out the shifter knob (F) Fig. 24.

The blade speed of 115 FPM is obtained by pushing in the shifter knob (F) Fig. 24, removing the long belt from the pulleys (B) and (E) and placing the small belt on the inside groove of the motor pulley (B) and the inside groove of the gear box pulley (E).

Except for the one speed of 115 FPM, both belts may be left on the machine regardless of the speed being used.

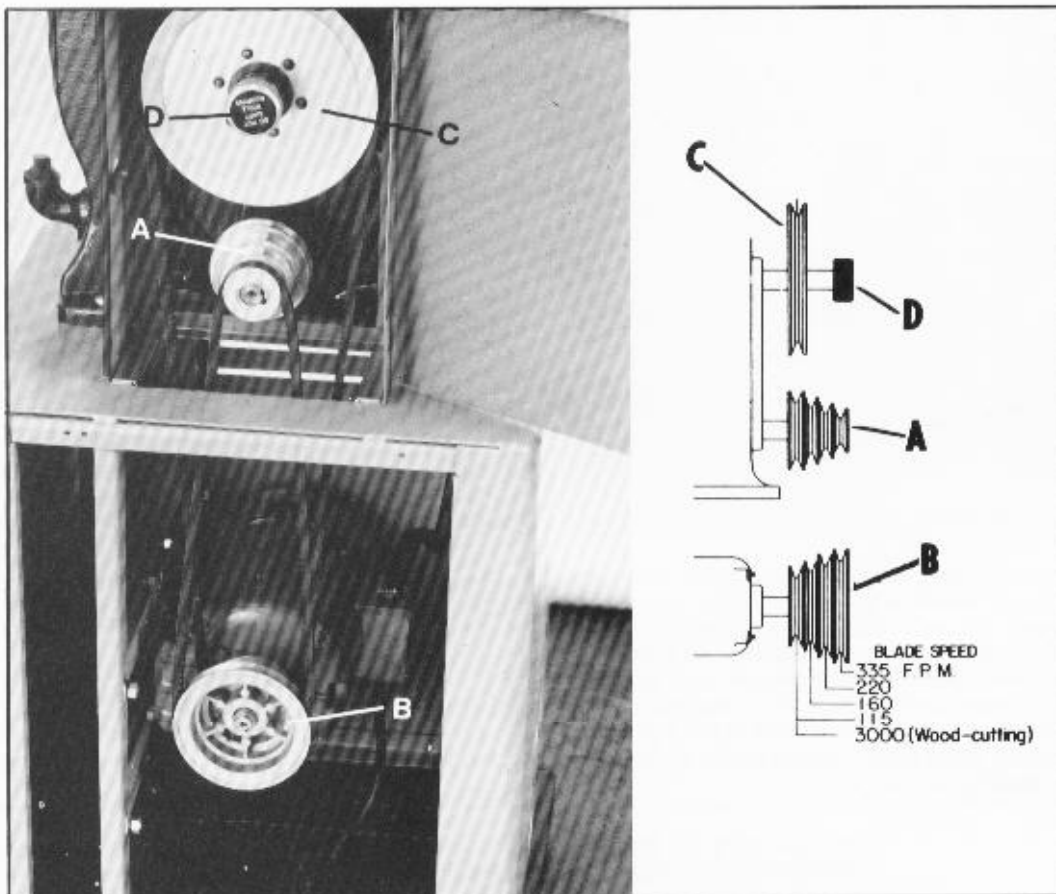

Fig. 25

Blade speeds of 115, 160, 220, 335 and 3000 FPM are available by simply interchanging the positions of the motor pulley and the gear box pulley. Fig. 25 shows the motor pulley (A) positioned on the gear box shaft and the gear box pulley (B) positioned on the motor shaft. Then with the long belt positioned on the inside groove of pulley (B) and pulley (C) and the small belt positioned in one of the remaining three grooves of the pulleys (A) and (B) Fig. 25 speeds of 160, 220, 335 FPM are obtained when the shifter knob (D) is pushed in. To obtain the 3000 FPM blade speed simply pull out the shifter knob (D) Fig. 25. Blade speed of 115 FPM is obtained by pushing in the shifter knob (D), removing the long belt from pulleys (B) and (C) and placing the small belt on the inside groove of the motor pulley (B) and gear box pulley (A).

Except for the one speed of 115 FPM, both belts may be left on the machine regardless of the speed being used.

CHANGING BLADES

To change blades, proceed as follows:

1. Open the upper and lower wheel guards.
2. Release tension on the band saw blade.
3. Remove the table adjustment pin and table insert.
4. Slip the blade off the wheel and guide it out through the slot in the table.
5. To install as new blade, reverse the above procedure.

SUGGESTED SPEEDS AND BLADES

MATERIAL	SUGGESTED METAL CUTTING BLADES AND SPEEDS THICKNESS OF MATERIAL						MISCELLANEOUS	SUGGESTED SKIP TOOTH BLADES AND SPEEDS THICKNESS OF MATERIAL					
	UNDER 1/4"		1/4" TO 3/4"		1" & UP			UNDER 1/2"		1/2" TO 2"		2" & UP	
STEELS	Teeth Per Inch	Feet Per Minute	Teeth Per Inch	Feet Per Minute	Teeth Per Inch	Feet Per Minute	Teeth Per Inch	Feet Per Minute	Teeth Per Inch	Feet Per Minute	Teeth Per Inch	Feet Per Minute	
Angle Iron	24	160	14	160			3	3000	3	3000	3	3000	
Armor Plate	16	40	14	40	10	40	4	3000	4	3000	4	3000	
Carbon Steel	24	85	14	60	14	40	4	3000	3	3000	3	3000	
Chromium Steel	24-18	85	14	60	14	40	6	3000	4	3000			
Cold Chilled Steel	24-18	220	14	220	14	160	4	3000	3	3000	3	3000	
Drill Rod	14	85	14	60			6	3000	4	3000	4	3000	
Grain 16 Steel	16	60	14	40	14	40	3	3000	3	3000	3	3000	
High Speed Steel	24	85	14	60	14	40	6	3000	4	3000	4	3000	
Machinery Steel	16	160	14	160	14	160	3	3000	3	3000	3	3000	
Molybdenum Steel	16	85	14	60	14	40	6	3000	4	3000	4	3000	
Nickel Steel	16	40	14	40	14	40	6	3000	4	3000	4	3000	
Silicon Manganese	18	85	14	85	14	60	6	3000	4	3000	4	3000	
Stainless Steel	24	40	14	40	10	40	6	3000	4	3000	4	3000	
Structural Steel	24	160	14	160	14	115	6	3000	4	3000	4	3000	
Tungsten Steel	16	40	14	40	10	40	6	3000	4	3000	4	3000	
FOUNDRY METALS													
Brass-Hard & Soft	16	335	14	335	10	335	6	3000	4	3000	4	3000	
Bronze-Aluminum	16	335	14	335	14	335	6	3000	4	3000	4	3000	
Bronze-Manganese	16	160	14	115	14	85	6	3000	4	3000	4	3000	
Bronze-Nickel	16	160	14	115	14	85	6	3000	4	3000	4	3000	
Bronze-Phosphorus	16	335	14	335	14	220	6	3000	4	3000	4	3000	
Cast Iron-Gray	16	115	14	85	10	80	6	3000	4	3000	4	3000	
Cast Iron-Malleable	16	160	14	115	14	85	6	3000	4	3000	4	3000	
Cast Steel	16	160	14	115	14	85	6	3000	4	3000	4	3000	
Copper-Beryllium	16	160	14	85	10	40	6	3000	4	3000	4	3000	
Gunite	24	335	18	220	14	160	6	3000	4	3000	4	3000	
Mechnite	16	160	14	115	10	85	6	3000	4	3000	4	3000	
Monel	16	115	14	85	10	60	6	3000	4	3000	4	3000	
Nickel-Cold Rolled	14	60	10	40	10	40	6	3000	4	3000	4	3000	
Nickel-Silver	16	220	14	220	14	220	6	3000	4	3000	4	3000	
Silver	24	220	16	220	14	220	6	3000	4	3000	4	3000	
NON-METALS													
Basalt	10	335	10	220	10	160							
Cork	10	3000	10	3000	10	3000							
Fibre	14	3000	10	3000	10	3000							
Hose-Canvas, Rubber	10	3000											
Hose-Metallic	24	220											
Mica	24	335	18	220	14	220							
Plastics	14	3000	14	3000	10	3000							
Porcelain	24	160	18	115									
Slate	24	335	18	220	14	160							
Transite	24	335	18	220	14	85							

SUGGESTED WOODCUTTING BLADES (3000 FPM)			
USE BLADE WIDTH TO SUIT DESIRED RADIUS			
WIDTH	MIN CUTTING RADIUS	WIDTH	MIN CUTTING RADIUS
1/8"	1/4"	3/8"	1"
3/16"	1/2"	1/2"	1-1/4"
1/4"	3/4"	3/4"	1-3/4"

Note - Some types of plastics lend themselves to more pronounced results with the regular band saw blades.
Sheets under 1/4" thickness and tubing under 1/4" wall thickness are not adapted to skip tooth blades.

Fig. 26

BAND SAW BLADES

A band saw blade is a delicate piece of steel that is subjected to tremendous strain. You can obtain long use from a band saw blade if you give it fair treatment. Be sure you use blades of the proper thickness, width, and temper for the various types of material to be cut.

Always use the widest blade possible. Use the narrow blades only for sawing small, abrupt curves and for fine delicate work. This will save blades and will produce better work. Band saw blades may be purchased, welded, set and sharpened ready for use. For cutting wood and similar materials we can supply them in widths of 1/8, 3/16, 1/4, 3/8, 1/2 and 3/4 inches.

Blades for metal cutting should be selected for the particular job they are to do. Blades for cutting thin metal, for example, should be selected so that there will always be at least two teeth in contact with the edge of the work. If the teeth are allowed to straddle the work they will be torn off and the blade ruined. Generally speaking, thick stock requires larger teeth and a slower cutting speed than thin stock. See Fig. 26, for recommendations of blades and cutting speeds, for different materials and thickness.

File and set the wood cutting blades whenever you find it requires pressure to make them cut. If a blade is broken it can be brazed or welded; however, if it has become badly work-hardened it will soon break in another place. If you are not equipped to file, set and braze or weld blades take them to a saw filer for reconditioning.

It is not practical to re-sharpened either the skip tooth blades or the regular hard-edge flexible-back metal cutting saw blades.

Any one of a number of conditions may cause a band saw blade to break. Blade breakage is, in some cases, unavoidable, being the natural result of the peculiar stresses to which such blades are subjected. It is, however, often due to avoidable causes, most often to lack of care or judgment on the part of the operator in mounting or adjusting the blade or guides. The most common causes of blade breakage are: (1) Faulty alignments and adjustments of the guides, (2) forcing or twisting a wide blade around a curve of short radius, (3) feeding too fast, (4) dullness of the teeth or absence of sufficient set, (5) excessive tightening of the blade, (6) top guide set too high above the work being cut, (7) using a blade with a bumpy or improperly finished braze or weld and, (8) continuous running of the saw blade when not in use for cutting.

New blades for the standard 14 inch Band Saw are 93 1/2 inches long. The adjustment will accommodate blades up to a maximum length of 94 inches and to a minimum length of 91 1/2 inches. When equipped with the No. 28-984 Height Attachment, new blades should be 105 inches long; maximum and minimum lengths are 106 and 103-1/2 inches.

OPERATING THE BAND SAW

Before starting the machine, see that all adjustments are properly made and the guards are in place. Turn the wheel by hand to make sure that everything is correct BEFORE turning on the power.

Keep the top guide down close to the work at all times. Do not force the material against the blade too hard. Light contact with the blade will permit easier following of the line and prevent undue friction, heating and work-hardening of the blade at its back edge.

KEEP THE SAW BLADE SHARP and you will find that very little forward pressure is required for average cutting. Move the stock against the blade steadily and no faster than will give an easy cutting movement.

Avoid twisting the blade by trying to turn sharp corners. Remember you must saw around corners.

CUTTING CURVES

When cutting curves, turn the stock carefully so that the blade may follow without being twisted. If a curve is so abrupt that it is necessary to repeatedly back up and cut a new kerf, either a narrow blade is needed or a blade with more set is required. The more set a blade has, the easier it will allow the stock to be turned, but the cut is usually rougher than where a medium amount of set is used.

In withdrawing the piece being cut, in order to change the cut, or for any other reason, the operator must be careful that he does not accidentally draw the blade off the wheels. In most cases it is easier and safer to turn the stock and saw out through the waste material, rather than try to withdraw the stock from the blade.

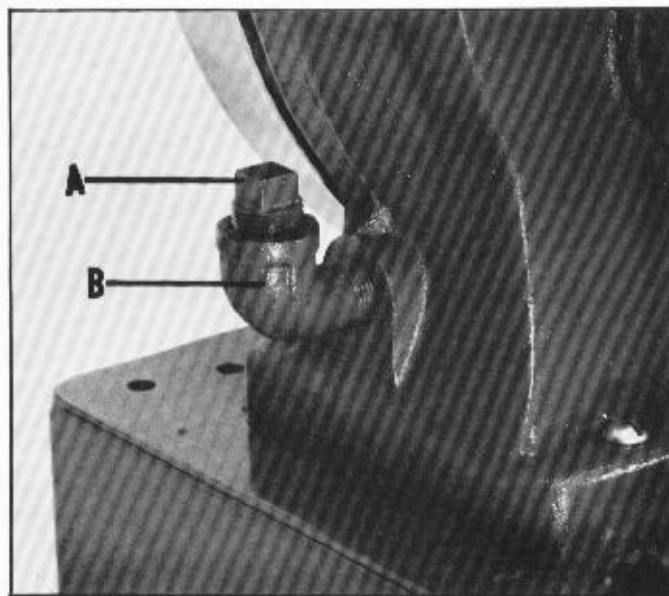

Fig. 27

LUBRICATION

The gear case is filled at the factory with 1-1/2 quarts of oil. It should be drained after 1500 to 2000 hours of operation and refilled with a good grade of heavy adhesive gear oil. A pipe plug is provided underneath the band saw and is removed when draining the oil.

All models are equipped with a 1/2 inch street elbow (B) Fig. 27, and a pipe plug (A).

Remove the pipe plug (A) Fig. 27, to check the level of oil in the gear case from time to time and keep it filled to insure proper gear lubrication.

The wheels of the band saw are carried on sealed for life ball bearings, which require no lubrication. Ball bearing blade supports are of the same type. Oil of every kind should be kept away from the blade supports.

Delta 14" Band Saw Accessories

For 14" Metal / Wood Cutting Band Saw

No. 41-713 Motor Pulley, 4-step, $\frac{5}{8}$ " bore. 1 lb.

No. 49-111 V-Belts, matched set of two, 41" and 58 $\frac{1}{2}$ " O.C.

For 14" Band Saws

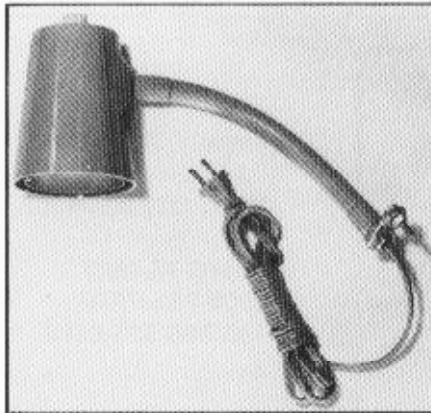

No. 25-858 Lamp Attachment, for 115 V. Includes 9" flexible gooseneck, reflector and 8-foot cord with plug. Uses standard bulb (not included) up to 40 watts. 2 lbs.

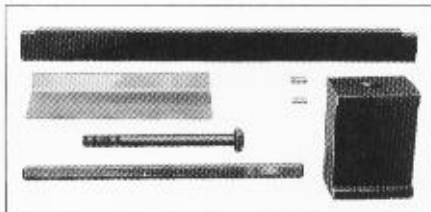

Height Attachment. Increases capacity of 14" Band Saw from 6 $\frac{1}{4}$ " to 12 $\frac{1}{4}$ " under the guide. Add at any time. Needs 105" blades.

No. 28-984 Height Attachment with cast block, dowels and bolt, extension front blade guard, wood back blade guard. 12 lbs.

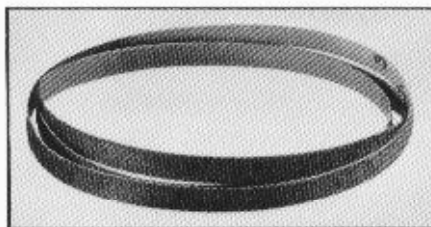

No. 28-836 Sanding Belt. Garnet type, five, No. 80 grit, fine, $\frac{1}{2}$ " wide, 91" long. 1 lb.

No. 28-837 Sanding Belt. Garnet type, five, No. 40 grit, medium, $\frac{1}{2}$ " wide, 91" long. 1 lb.

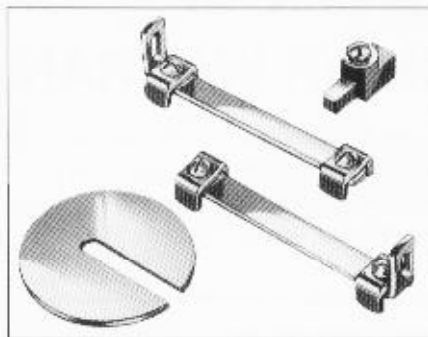

No. 28-810 Sanding Attachment. Includes flat and curved platens with guides and mounting brackets. 1 lb.

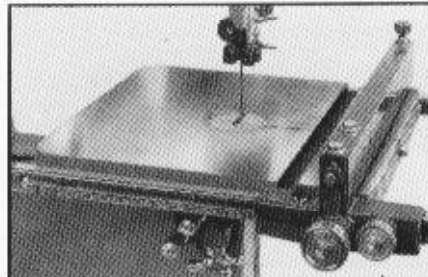

No. 28-843 Rip Fence. With 18" guide bars and mounting screws. 8 lbs.

No. 28-845 Rip Fence. With 32" guide bars and mounting screws. 12 lbs.



No. 34-895 Miter Gage. For straight and angle operations. Has $\frac{3}{8}$ x $\frac{3}{4}$ x 18" guide bar and pivoting work support body with pointer and calibrations reading through 120° swing. Adjustable, positive stops at 90° and 45° positions. 4 lbs.

No. 34-568 Clamp Attachment for Miter Gage. With clamp bar, two sliding clamp screws, and front and rear posts. 1 $\frac{1}{2}$ " lbs.

No. 34-873 Extra Clamp Screw and Block. For Clamp Attachment. $\frac{1}{2}$ lb.

Wood Cutting Band Saw Blades. 93 $\frac{1}{2}$ " blades are standard; 105" blades used with 28-984 Height Attachment. $\frac{1}{2}$ lb.

Number (93 $\frac{1}{2}$ " Long)	Number (105" Long)	Width	Min. Cut. Rad.	Teeth Per In.
28-032	28-045	$\frac{1}{8}$ "	$\frac{1}{4}$ "	12
28-033	28-046	$\frac{3}{16}$ "	$\frac{5}{16}$ "	6
28-034	28-047	$\frac{1}{4}$ "	$\frac{5}{8}$ "	6
28-036	28-048	$\frac{3}{8}$ "	1 $\frac{1}{16}$ "	5
28-038	28-050	$\frac{1}{2}$ "	2 $\frac{1}{2}$ "	5
28-040	28-052	$\frac{3}{4}$ "	5 $\frac{1}{16}$ "	4

Skip Tooth Band Saw Blades

For cutting aluminum, magnesium, plastics and all kinds of wood. All blades are 93 $\frac{1}{2}$ " long. $\frac{1}{2}$ lb.

Number	Width	Minimum Cut. Rad.	Teeth Per In.
28-884	$\frac{1}{4}$ "	$\frac{5}{8}$ "	6
28-885	$\frac{3}{8}$ "	1 $\frac{1}{16}$ "	4
28-886	$\frac{1}{2}$ "	2 $\frac{1}{2}$ "	4
28-887	$\frac{3}{4}$ "	5 $\frac{1}{16}$ "	4

Metal Cutting Band Saw Blades

These are regular set, hard-edge, flexible-back standard blades for cutting all metals. All blades are 93 $\frac{1}{2}$ " long. $\frac{1}{2}$ lb.

Number	Width	Minimum Cut. Rad.	Teeth Per In.
28-058	$\frac{1}{2}$ "	2 $\frac{1}{2}$ "	10
28-060	$\frac{1}{2}$ "	2 $\frac{1}{2}$ "	14
28-062	$\frac{1}{2}$ "	2 $\frac{1}{2}$ "	18
28-064	$\frac{1}{2}$ "	2 $\frac{1}{2}$ "	24

Delta Industrial Distributors

Your local Industrial Distributor, who makes Delta Industrial Machines and Accessories conveniently available to you, also can assist you with expert application engineering. He is as close to you as your phone. He is always willing to help you by making prompt, emergency deliveries of hundreds of items which could prevent costly shutdowns and delays. Depend on him for all of your industrial requirements, just as Delta does at all of its plant locations.



PARTS, SERVICE OR WARRANTY ASSISTANCE

All Delta Machines and accessories are manufactured to high quality standards and are serviced by a network of factory service centers and authorized service stations listed in your owner's manual. To obtain additional infor-

mation regarding your Delta quality product or to obtain parts, service or warranty assistance, please call or fax Delta's toll-free 'hotline' number.

Delta maintains a modern, efficient Parts Distribution Center, maintaining an inventory of over 15,000 parts located in Memphis, Tennessee.

Highly qualified and experienced Customer Service Representatives are standing by to assist you on weekdays from 7:00 A.M. to 5:00 P.M. Memphis time.



Memphis, TN 38118
4290 Raines Road
Phone: (901) 363-8800

HOTLINE
800-223-PART
FAX: 800-535-6488

DELTA **Two Year Limited Warranty** **Delta Machinery**

Delta will repair or replace, at its expense and at its option, any Delta machine, machine part, or machine accessory which in normal use has proven to be defective in workmanship or material, provided that the customer notifies his supplying distributor of the alleged defect within two years from the date of delivery to him, of the product and provides Delta Machinery with reasonable opportunity to verify the defect by inspection. Delta Machinery may require that electric motors be returned prepaid to the supplying distributor or authorized service center for inspection and repair or replacement. Delta Machinery will not be responsible for any asserted defect which has resulted from misuse, abuse or repair or alteration made or specifically authorized by anyone other than an authorized Delta service facility or representative. Under no circumstances will Delta Machinery be liable for incidental or consequential damages resulting from defective products. This warranty is Delta Machinery's sole warranty and sets forth the customer's exclusive remedy, with respect to defective products; all other warranties, express or implied, whether of merchantability, fitness for purpose, or otherwise, are expressly disclaimed by Delta.